

Article number: 09068730

Description: KLEE Feather keys B 8x7x30 DIN 6885

## Measures

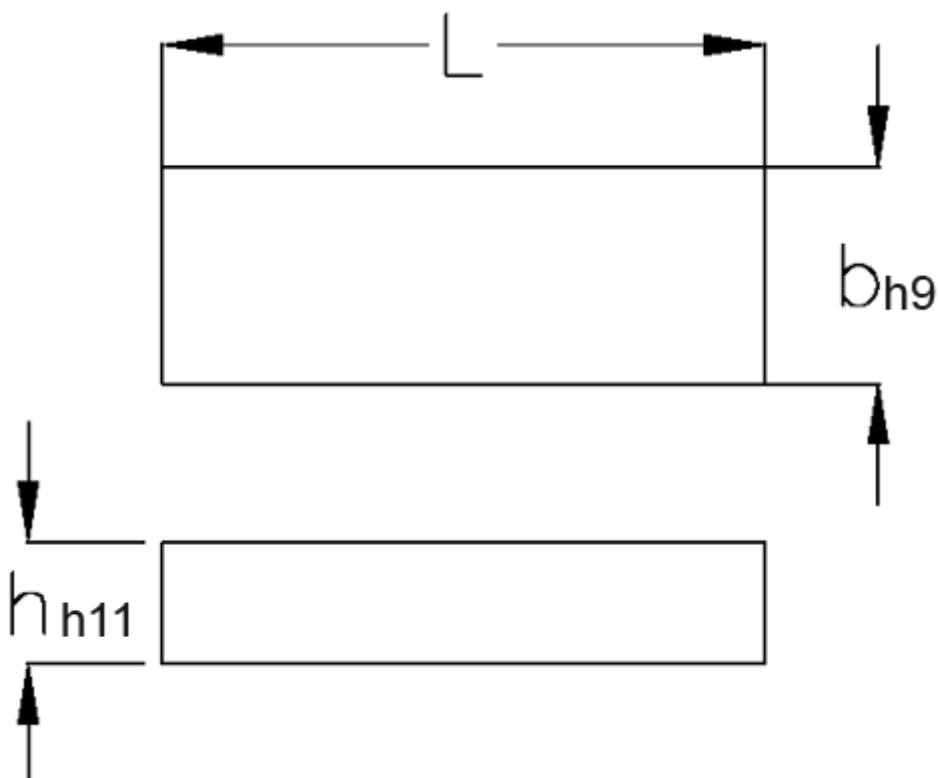

b	= 8
h	= 7
L	= 30
Tolerance b	= 0.036
Tolerance h	= 0.090
Tolerance L	= -0,3